

Corte AA Cobertura 02
Esc: 1/75

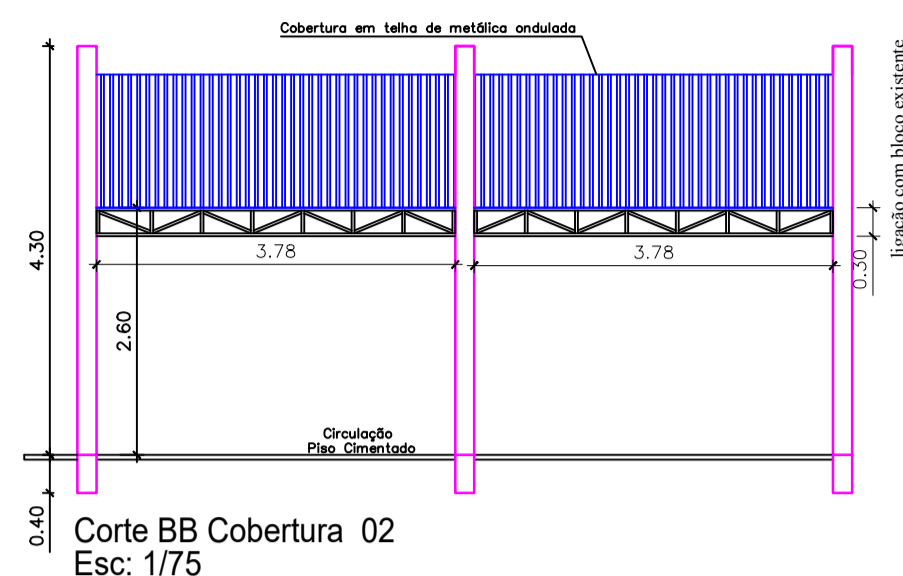

Corte BB Cobertura 02
Esc: 1/75

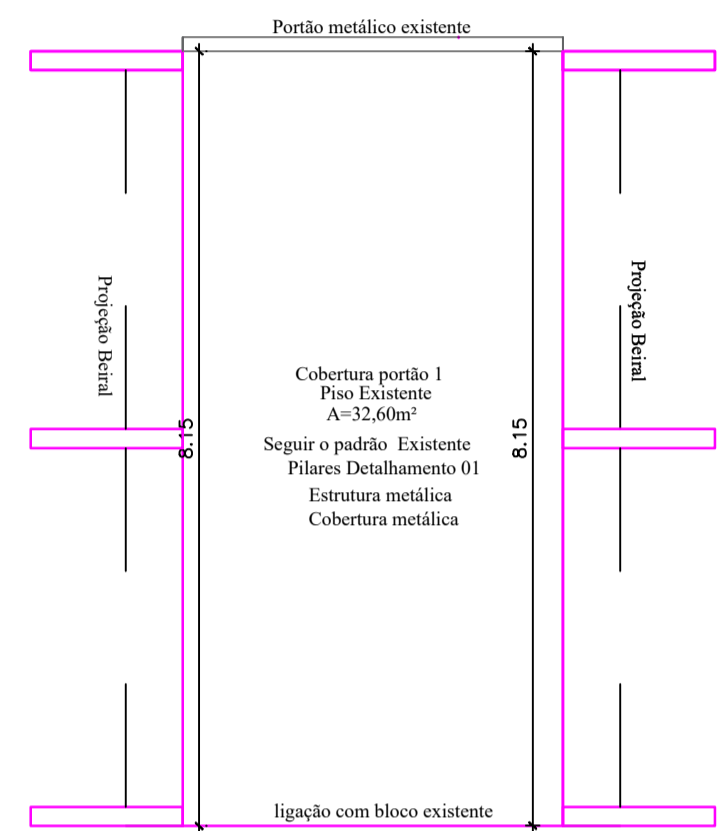

Planta Baixa Cobertura 02
Esc: 1/75

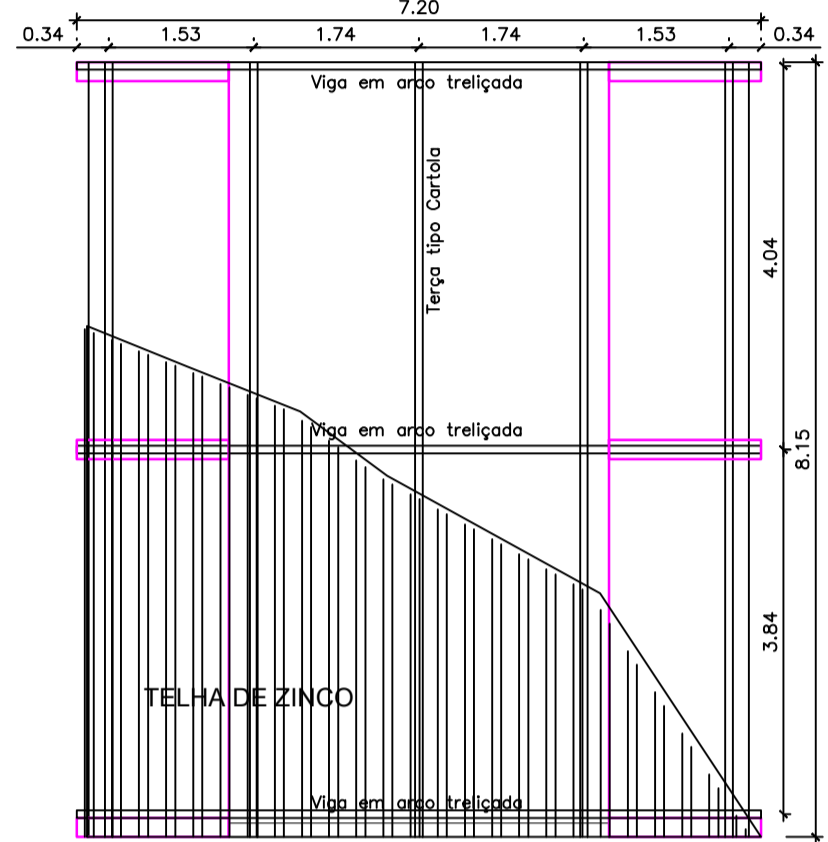

Planta de Cobertura 02
Esc: 1/75

DETALHES COBERTURA 02

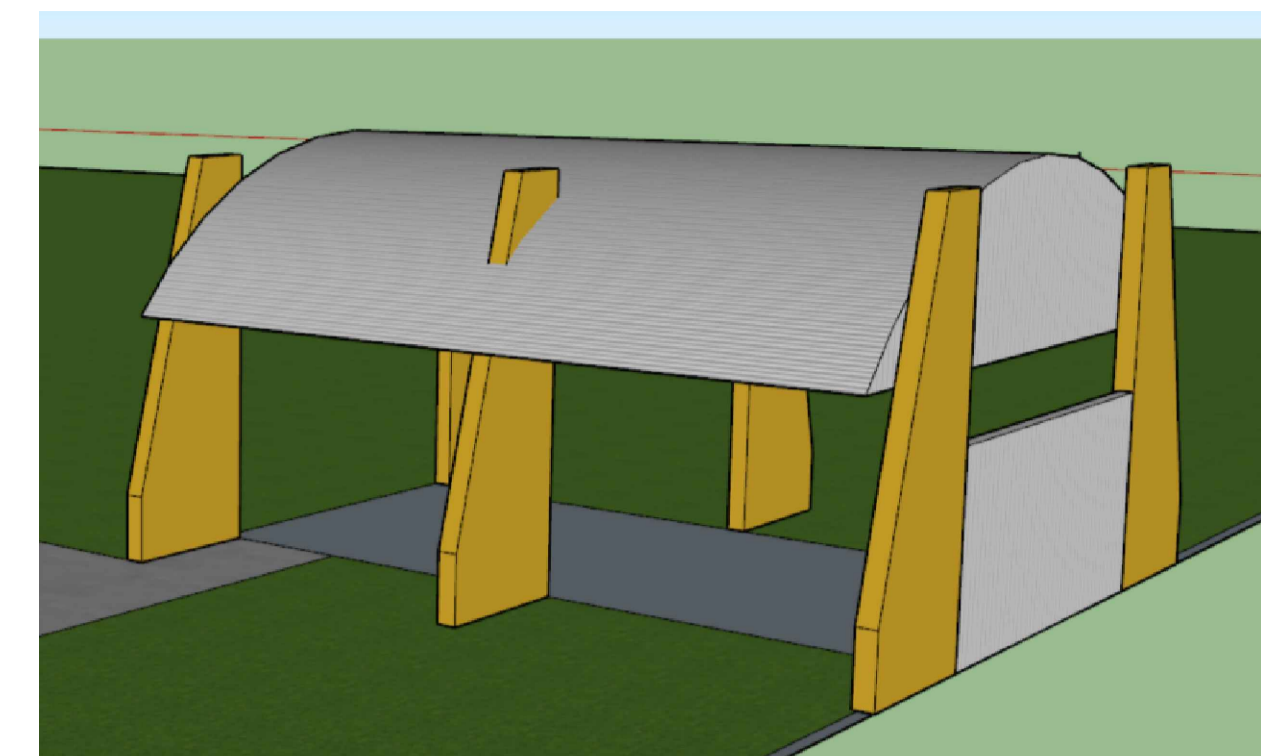
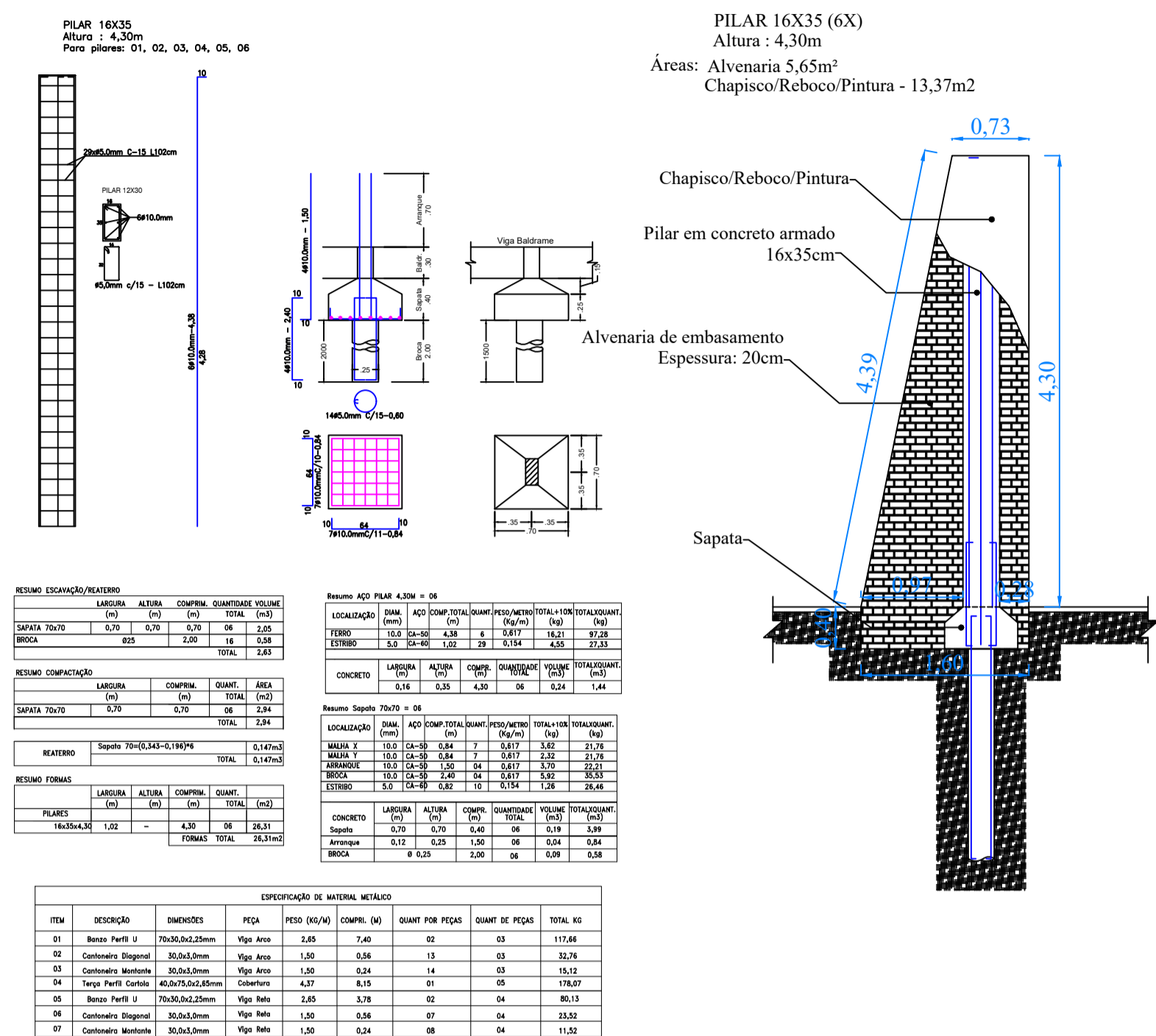

DETALHES COBERTURA 04

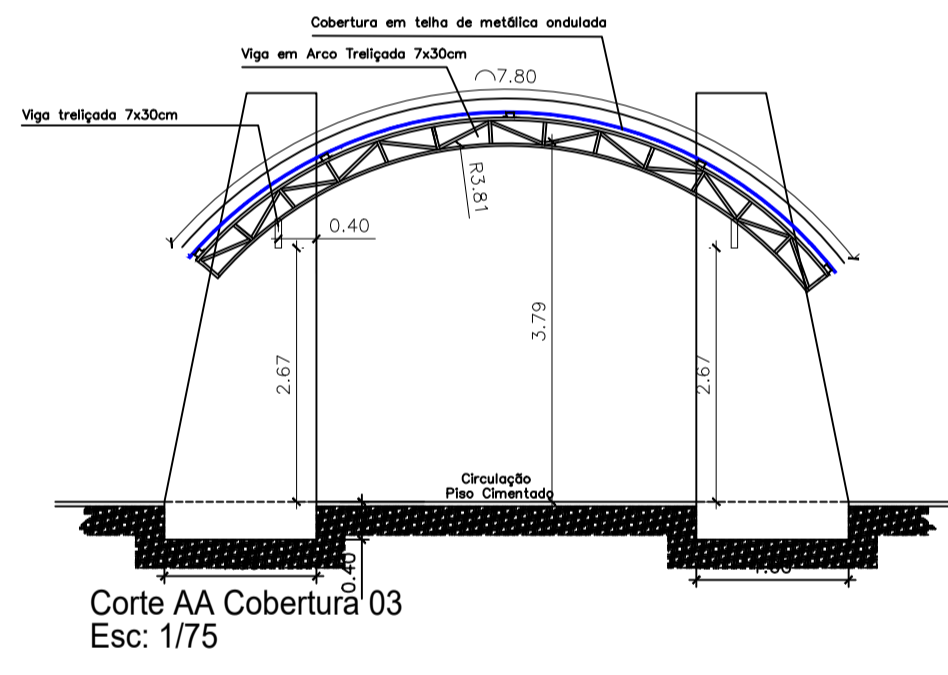
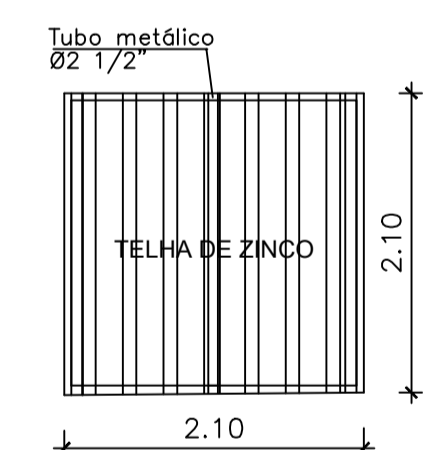
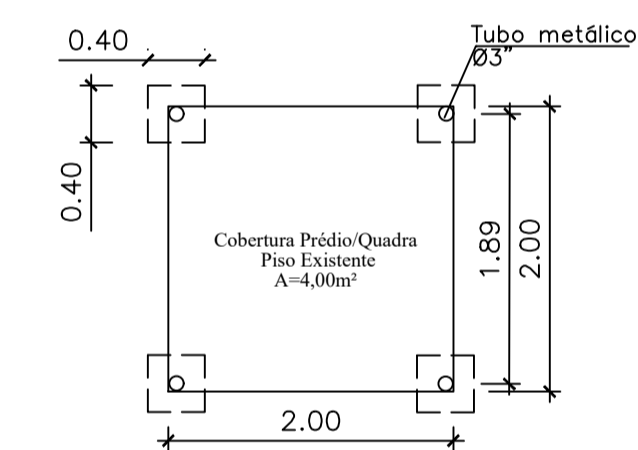
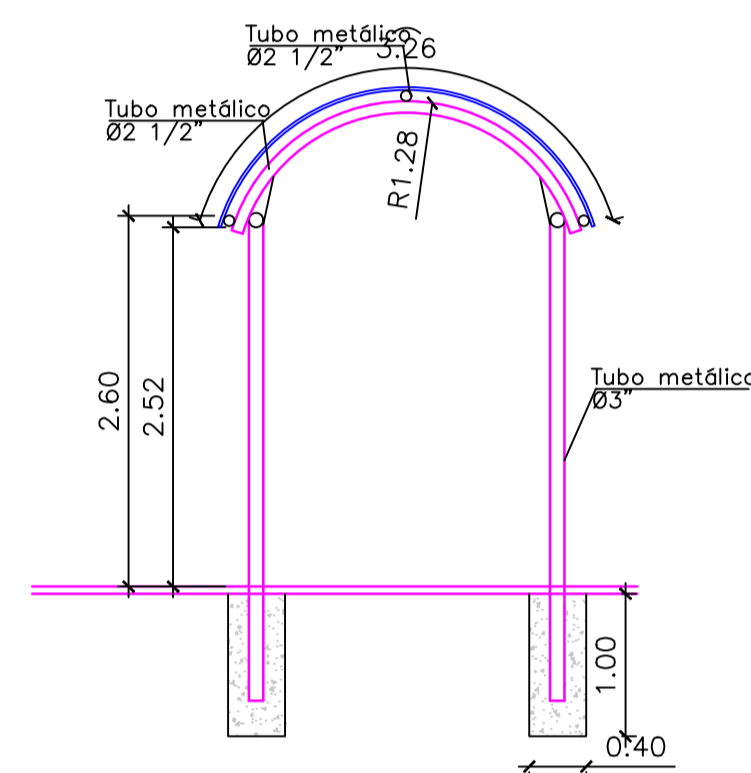

Corte AA Cobertura 03
Esc: 1/75

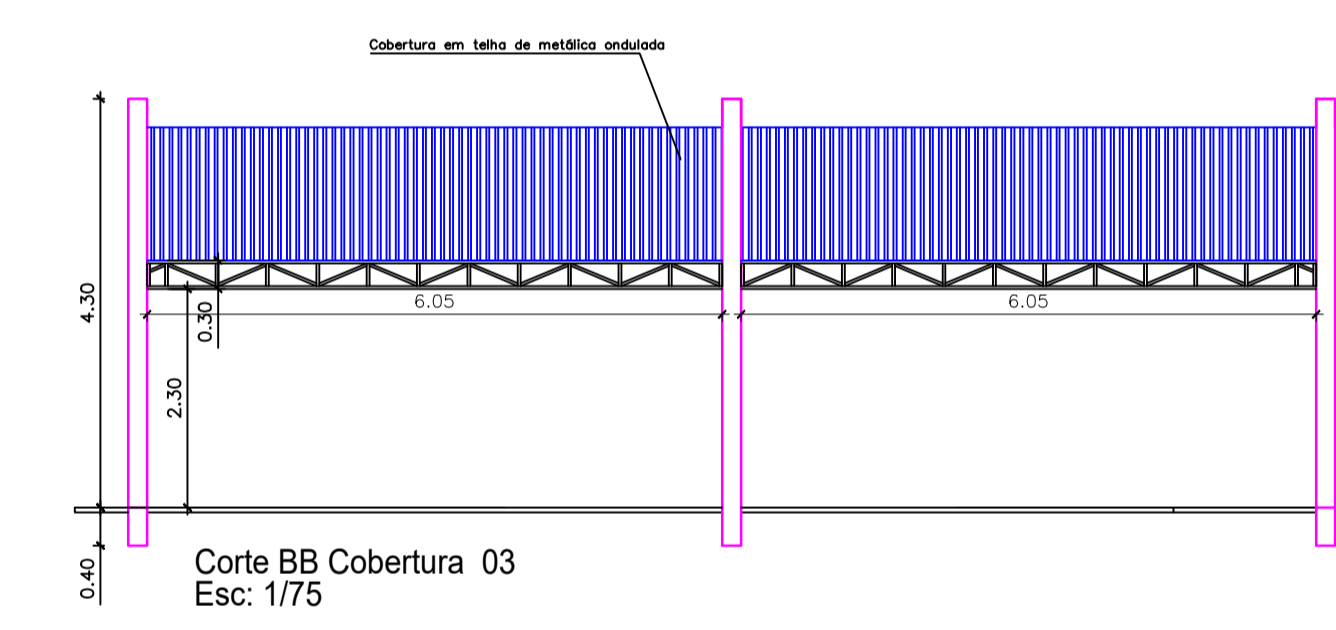

Corte BB Cobertura 03
Esc: 1/75

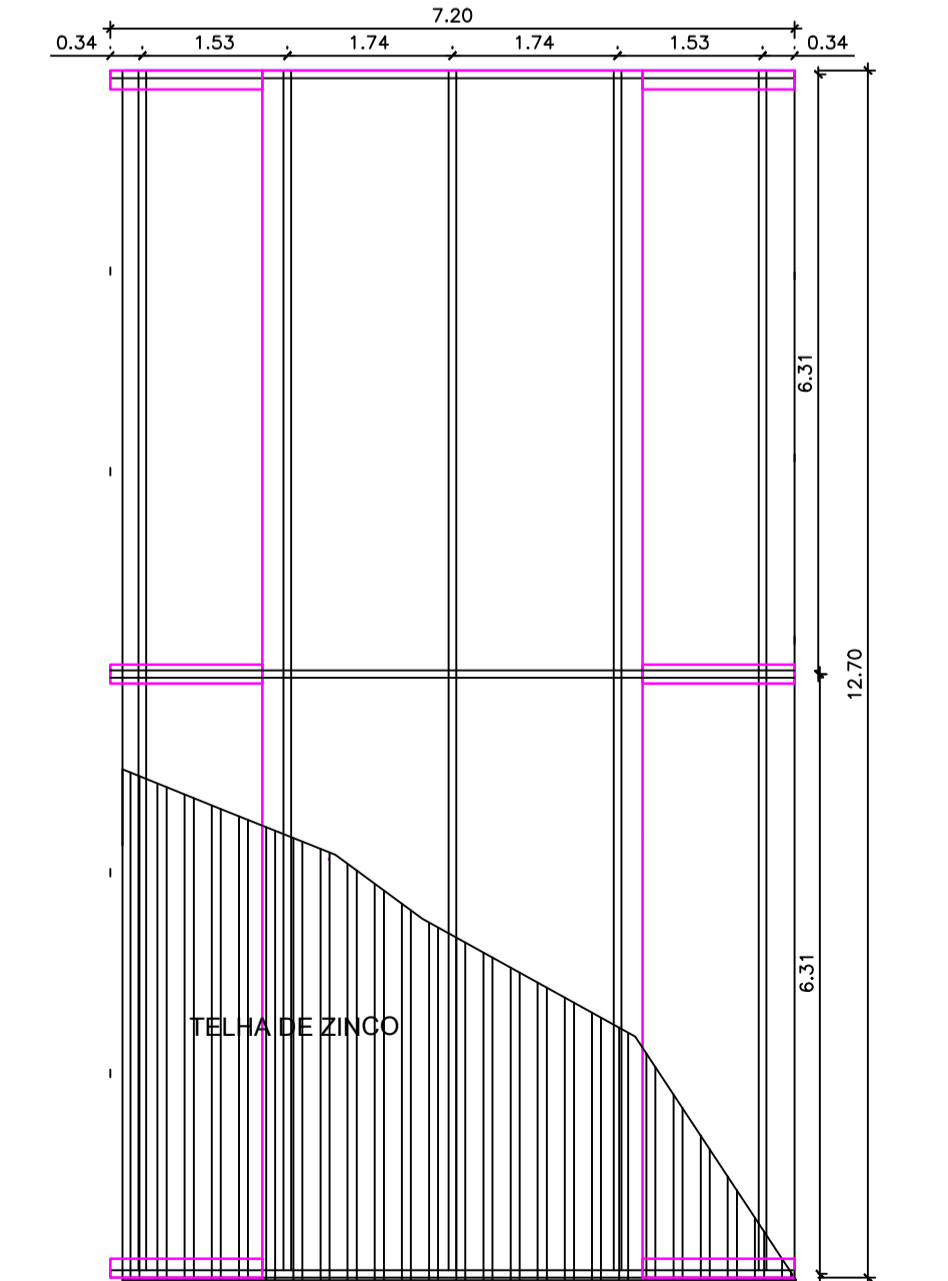

Planta de Cobertura 03
Esc: 1/75

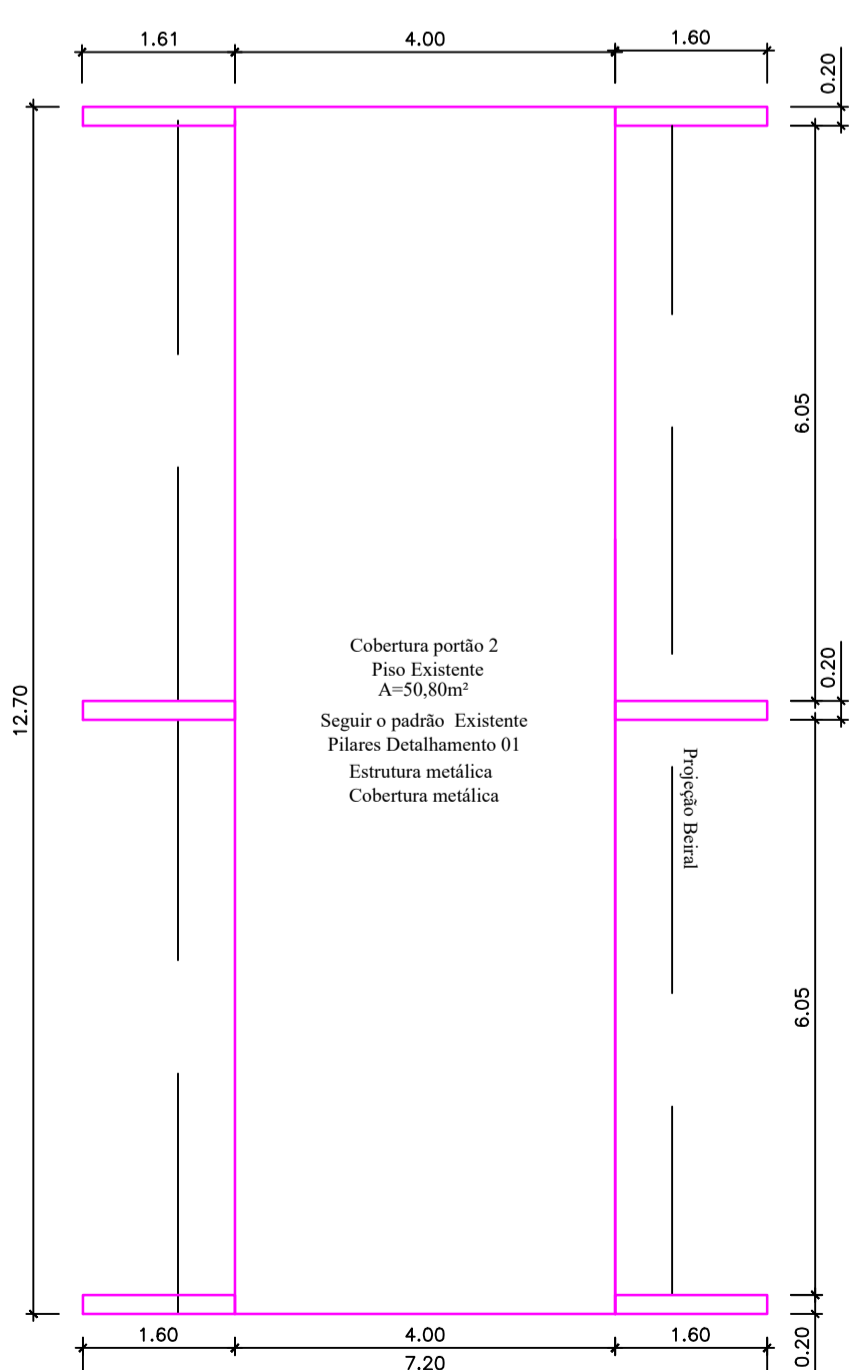

Planta Baixa Cobertura 03
Esc: 1/75

DETALHES COBERTURA 03

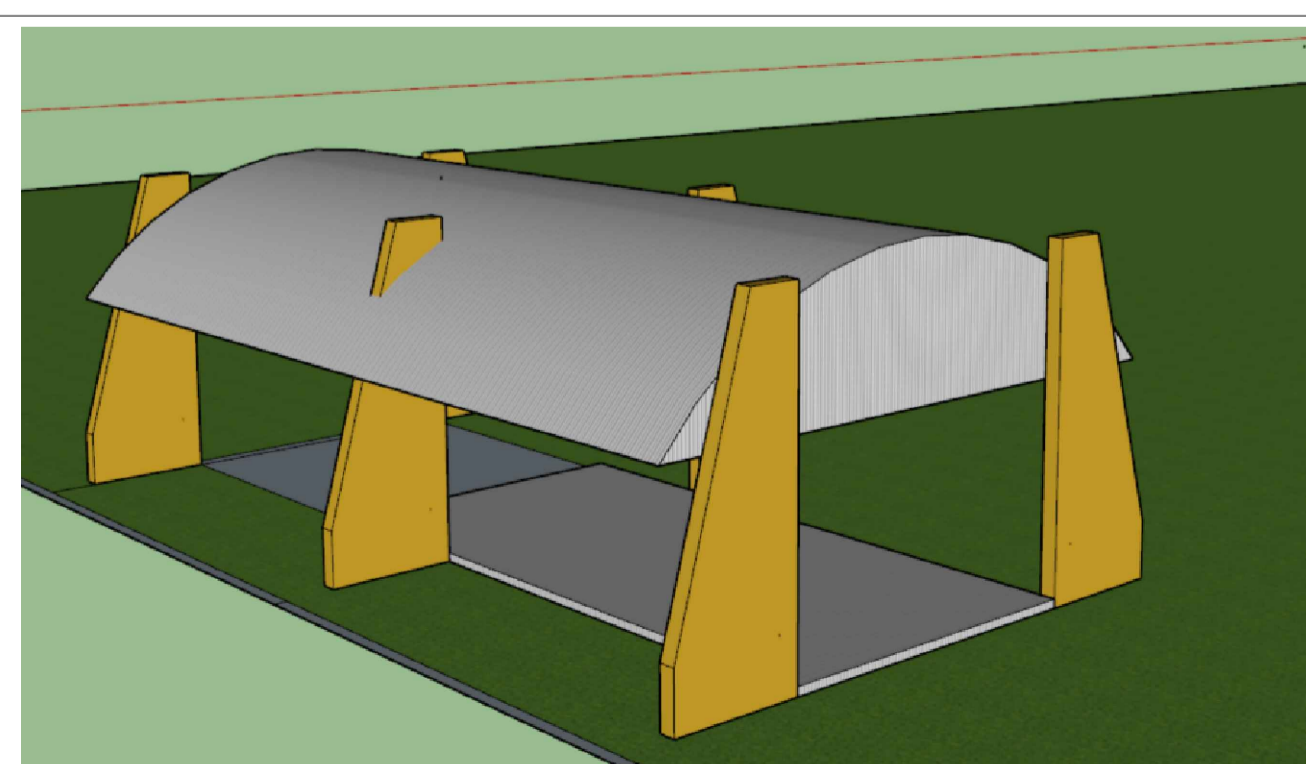
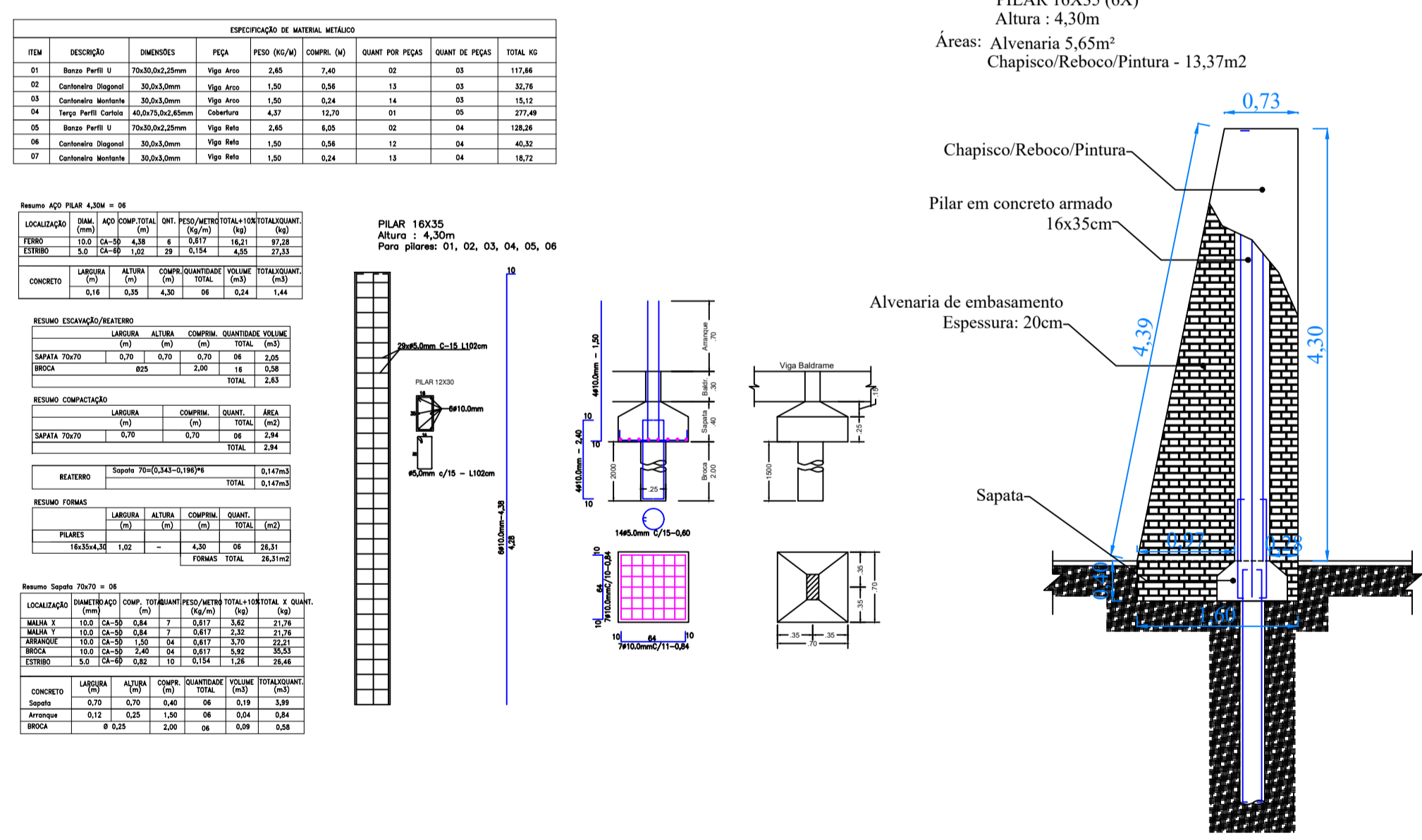

Obras:
PROJETO COBERTURAS METÁLICAS E ADEQUAÇÕES NA ESCOLA MUNICIPAL GERMANO LAZARETTE LOCAL: RUA MARECHAL C. RONDON QUADRA 10, LOTE 21

Área:
Cobertura 01130,01m²
Cobertura 0232,60m²
Cobertura 0350,80m²
Cobertura 044,00m²
Total217,41m²

PREFEITURA DE CAMPOS DE JÚLIO-MT

CINTYA VIEIRA SOUTO
Arquiteta e Urbanista
Responsável Técnico
CAU 134752-7

Conteúdo: ARQUITETÔNICO
- Cobertura 02
- Cobertura 03
- Cobertura 04

DECLARO QUE A APROVAÇÃO DO PROJETO NÃO IMPLICA NO RECONHECIMENTO POR PARTE DA PREFEITURA DO DIREITO DE PROPRIEDADE DO TERRENO.